


Article

# Chance-Constrained Dynamic Programming for Multiple Water Resources Allocation Management Associated with Risk-Aversion Analysis: A Case Study of Beijing, China

Wei Li <sup>1,\*</sup>, Kuo Jiao <sup>1</sup> , Zhe Bao <sup>1</sup>, Yulei Xie <sup>2</sup>, Jiliang Zhen <sup>3</sup>, Guohe Huang <sup>1</sup> and Lingbo Fu <sup>4</sup>

<sup>1</sup> MOE Key Laboratory of Regional Energy and Environmental Systems Optimization, S-C Resources and Environmental Research Academy, North China Electric Power University, Beijing 102206, China; jiaokuo5039@foxmail.com (K.J.); baozhe\_1988@163.com (Z.B.); huang@iseis.org (G.H.)

<sup>2</sup> School of Energy and Environmental Engineering, University of Science and Technology Beijing, Beijing 100083, China; xieyulei850228@yahoo.com.cn

<sup>3</sup> School of Science, Beijing University of Civil Engineering and Architecture, Beijing 100044, China; zhenjiliang@live.com

<sup>4</sup> College of Electrical Engineering, Guangxi University, Nanning 530004, China; fulingbo2011@163.com

\* Correspondence: weili81927@163.com; Tel.: +86-010-6177-2976

Received: 29 April 2017; Accepted: 3 August 2017; Published: 11 August 2017

**Abstract:** Water shortage and water pollution have become major problems hindering socio-economic development. Due to the scarcity of water resources, the conflict between water supply and demand is becoming more and more prominent, especially in urban areas. In order to ensure the safety of urban water supply, many cities have begun to build reservoirs. However, few previous studies have focused on the optimal allocation of water resources considering storage reservoirs. In this study, a multi-water resources and multiple users chance-constrained dynamic programming (MMCDP) model has been developed for water resources allocation in Beijing, China, which introduces reservoir and chance-constrained programming into the dynamic programming decision-making framework. The proposed model can distribute water to different departments according to their respective demands in different periods. Specifically, under the objective of maximal benefits, the water allocation planning and the amount of water stored in a reservoir for each season under different feasibility degrees (violating constraints or available water resources situations) can be obtained. At the same time, the model can be helpful for decision-makers to identify the uncertainty of water-allocation schemes and make a desired compromise between the satisfaction degree of the economic benefits and the feasibility degree of constraints.

**Keywords:** chance-constrained programming; water supply; multi-water resources; reservoir regulation; uncertainty

## 1. Introduction

As an important natural resource, water is vital for supporting regional economic development and improving human-beings' quality of life in densely populated areas (i.e., urban areas). In the last twenty years, with socioeconomic development, the acceleration of the urbanization process, and increasing population, water consumption has been obviously increasing in urban areas. In the past decades, water shortage problems have been relieved to a certain degree through protecting the existing water resources and exploiting new water resources. Nevertheless, due to the continuously increasing water demand and decreasing available water resources, the above two measures are becoming invalid [1]. Simultaneously, water shortage has seriously hindered the sustainable development of the

Primary, Secondary, and Tertiary industry, which would pose a threat to social security and stability. In addition, there are still a variety of uncertainties existing in the water resources management system, such as available water amount, water consumption, multiple water sources, water conflicted users, and technical–economic parameters [2]. These uncertain factors could be an obstacle to the formulation of rational water resources utilization, and lead to conflict-laden water allocation among multiple competing users [3]. Therefore, the development of effective water resources management and protection schemes is desired in urban areas under uncertainty.

Previously, a number of inexact optimization methods were proposed for water resources allocation management [4–8]. For example, based on chance-constrained programming, Huang (1998) presented an inexact-stochastic programming model for water quality management in an agricultural system, which could provide a trade-off between environmental objectives and an economic system [9]. Li et al., 2008, advanced an interval-parameter robust quadratic programming method for regional water resources system management, where nonlinearities in the objective function were reflected by robust programming and interval quadratic programming [10]. Guo et al., 2009, developed a two-stage fuzzy chance-constrained programming for water sources management under uncertainty, which could provide a desired water distribution plan by maximizing the system's benefits [11]. Li et al., 2009, proposed a hybrid fuzzy-stochastic model for agricultural water management, where fuzziness and randomness could be expressed as a multilayer scenario tree [12]. Li et al., 2009, developed a multistage fuzzy-stochastic programming method for water resources allocation under uncertainty, in which a number of uncertainties were estimated as fuzzy sets and probability distributions [13]. Xie et al., 2011, proposed an inexact-chance-constrained regional water quality management model, which can support policies of wastewater discharge and government investment. The model also provides compromises among economic benefits, system reliability and pollutant discharges [14]. Xu et al., 2014, advanced a rank-based fuzzy optimization approach for agricultural farming water supply, which can help decision-makers to find cost-effective solutions under different probabilities of violation risk [15]. Wang et al., 2015, proposed an inexact multi-stage dual-stochastic programming to deal with the problem of urban water resources allocation, where uncertainties could be addressed by incorporating interval-parameter programming, dual-stochastic programming and multi-stage optimization programming [16].

From the above analysis, these inexact optimization methods can effectively solve some problems, including water allocation, trade-off between economic benefits and environmental objectives, and various uncertainties that exist in water resources management [17]. For a water resources system coupled with multiple water sources, multiple water sources can provide a strong water guarantee and alleviate the contradiction between water supply and demand. However, multiple water sources will make the water supply system more complicated and bring about new requirements for local water resources allocation management. Therefore, how to balance the quantity of water intake from different water sources and identify the uncertainty in water-allocation planning still needs some special approaches in order to be resolved.

Among those proposed inexact optimization methods, chance-constraints programming can effectively address independent random variables in the constraints [18]. Moreover, it can integrate other optimization methods within a general framework to tackle the uncertainty in water sources management. However, few studies have focused on the chance-constrained dynamic programming model for dispatching water resources from multi-water sources in urban areas.

Therefore, the objective of this study is to develop an interactive dynamic programming model which can provide optimal alternatives over multiple periods for decision-makers. Through incorporating the multiple sources with reservoir regulation and chance-constrained programming into the dynamic decision-making framework, the multi-water resources and multiple users chance-constrained dynamic programming (MMCDP) model can allocate multiple water sources to multiple users. MMCDP is useful for dealing with random variables in the constraints and generating the water supply allocation schemes coupled with the deployment of multiple water

sources. Moreover, it can help decision-makers to not only acquire the maximum system net benefits under different violating constraints, but also identify desired compromises between the satisfaction degree of the economic benefits and the feasibility degree of the constraints.

## 2. Model Development

### 2.1. Multi-Water Sources and Multiple Users Dynamic Programming (MMDP) Model

It is assumed that there is such a case, wherein decision-makers are responsible for allocating limited water resources to multiple water sectors over a multi-period planning horizon. In order to maximize the system net benefits in the planning periods, decision-makers need to make a proper plan to distribute water to the water-use sectors in different stages. According to the water-use sectors' water demands, the various situations of water resources and the local water resources management policies, decision-makers would predetermine the amount of water for the different departments in the coming year. It is assumed that whether the water-use sectors can generate net benefits in different periods or receive the penalty income of the department caused by water shortage is decided by the promised water [19]. The excess water would be produced frequently during the water distribution process, which is deemed to be a significant problem. In the past, the abandoned water problem could be addressed by introducing an uncertain parameter; comparatively, in this study, it could be solved through the integrated dynamic programming and the city's storage reservoir.

The system framework of multi-water sources dynamic programming with the storage reservoir model is shown in Figure 1. In each stage, managers can purchase water from different water sources with different prices. When, in the decision-maker's opinion, purchased water is greater than all user demands, part of the water would be stored in a reservoir for the next quarter's allocation. The purchased water and the stored water in the reservoir could be allocated to each water-use sector in a pre-regulated plan. Tables 1 and 2 present the model parameters and variables, respectively.

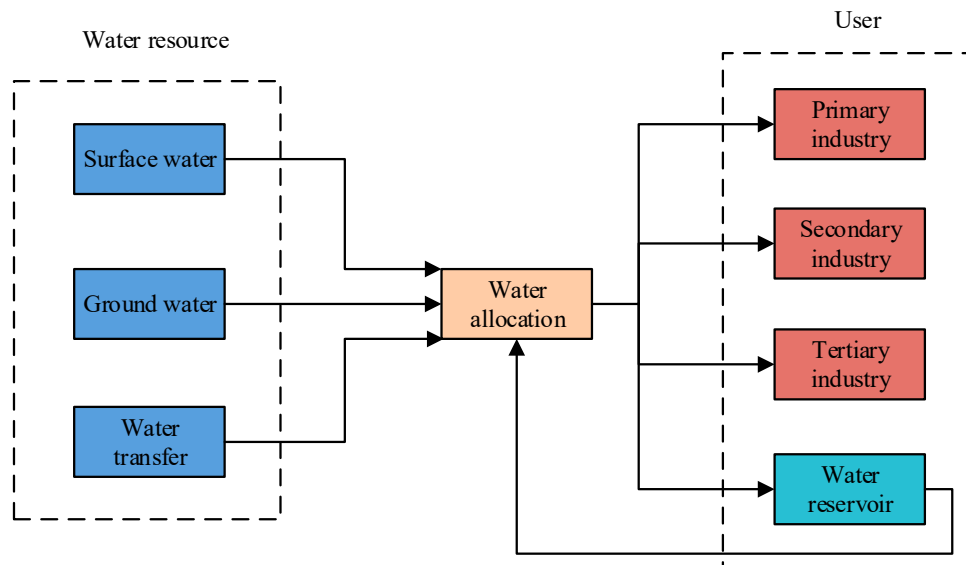


Figure 1. The multiple water sources for urban water supply system structure.

**Table 1.** Model parameters.

Parameter	Magnitude
Index $i$	Denotes the different supply sources, i.e., surface water, groundwater, water transfer
Index $j$	Denotes the different users, i.e., the Primary industry, the Secondary industry, the Tertiary industry
$t$	Time interval or period, four seasons
$B_{ij}$	The benefit for the use of the water from user $j$ in the period $t$ (RMB/m <sup>3</sup> )
$D_{ij}$	Demand of water from user $j$ in the period $t$ (m <sup>3</sup> )
$Y_{ij}^{\min}$	Minimum water flow to user $j$ in the period $t$ (m <sup>3</sup> )
$S_{ti}$	Capacity of the supply source $i$ (m <sup>3</sup> ) in the period $t$ , when the obtainable water follows Gaussian distribution.
$P_{tj}$	Penalty for not satisfying the demand of user $j$ in the period $t$ (RMB/m <sup>3</sup> )
$X_{ti}$	The cost of water from supply water source $i$ in the period $t$ (RMB/m <sup>3</sup> )
$V_{\max}$	Maximum volume of water that can be stored in the water reservoir (m <sup>3</sup> )
$V_{\min}$	Minimum volume of water that should be stored in the water reservoir (m <sup>3</sup> )
$K_t$	Maximum volume of time interval or period

**Table 2.** Model variables.

Variable	Magnitude
$M_{ti}$	The quantity of purchased water from supply source $i$ in the period $t$ (m <sup>3</sup> )
$Y_{tj}$	Water flow allocated to user $j$ in the period $t$ (m <sup>3</sup> )
$LW_t$	Water volume stored in the reservoir in the period $t$ (m <sup>3</sup> )

The water distribution problem can be formulated as a multi-water sources and multiple users dynamic programming (MMDP) model. In MMDP, multi stage water allocation is transformed into a series of single stages by dynamic programming. Using the relationships between the stages, MMDP can calculate the maximum benefit of the total planning periods. The MMDP model can be formulated as follows:

$$Max F_t = \sum_{t=1}^T \sum_{j=1}^J NB_{tj}Y_{tj} - \sum_{t=1}^T \sum_{j=1}^J p_{tj}(D_{tj} - Y_{tj}) - \sum_{t=1}^T \sum_{i=1}^I M_{ti}x_i \tag{1a}$$

subject to

$$Y_{tj}^{\min} \leq Y_{tj} \leq D_{tj} \quad \forall t, j \tag{1b}$$

$$V_{\min} \leq LW_t \leq V_{\max} \quad \forall t \tag{1c}$$

$$\sum_{i=1}^I M_{ti} + LW_t - \sum_{j=1}^J Y_{tj} = LW_{t+1} \quad \forall t \tag{1d}$$

$$\sum_{j=1}^J Y_{tj} \leq \sum_{i=1}^I M_{ti} + LW_t \quad \forall t \tag{1e}$$

$$0 \leq M_{ti} \leq S_{ti} \quad \forall t, i \tag{1f}$$

In the formula

$$LW_1 = V_{\min} \tag{1g}$$

## 2.2. Multi-Water Sources and Multiple Users Dynamic Programming Model for Optimal of Water Allocation

The following analysis is on the relationship between the variables of MMDP and the model constraints.

### 2.2.1. State Variables

Firstly, by the definition of state variables, the following conclusions can be drawn:

The amount of different water sources in different seasons can be expressed by Gaussian distribution  $S_{ti} \sim N(\mu_{ti}, \sigma_{ti}^2)$ . The total water amount is the state variable.

$$S_t = \sum_{i=1}^I S_{ti} + LW_t \quad \forall t \quad (2)$$

where  $LW_1 = V_{\min}$ .

Secondly, by the definition of decision variables, the state variable is  $S_t$  at the beginning of the  $t$  phase, when the MMDP determines the decision variables  $(M_{ti}, Y_{tj})$ , which will affect the next stage of the state variables  $S_{t+1}$ . Details are as follows:

In a certain stage of the whole horizon, the water allocation plan will produce a portion of unallocated water  $LW_t$  stored in a water regulating reservoir.

The continuity equation (state transition equation) in the water reservoir is equality (1c).

Moreover, the amount of storage water in the reservoir should not be lower than the minimum storage capacity of the reservoir and not greater than the maximum storage capacity to ensure the normal operation and the ecological function of the regulating reservoir [20]. At the same time, the water amount of the reservoir at the end of the planning period should not be less than the initial storage amount [21]. The upper and lower bounds of the reservoir (in order to simplify the calculation in practice, this study will ignore the evaporation of water) can be formulated as inequality (1d).

In summary, when the MMDP determines the decision variables  $(M_{ti}, Y_{tj})$  at  $t$  stage, the state variable  $S_t$  and  $S_{t+1}$  should satisfy Formula (1c,d).

### 2.2.2. The Decision Variables

Firstly, at the beginning of the  $t$  phase, the purchased water should not exceed the water supply of the water source at this stage. Limitations of each water supply source are inequality (1f).

The maximum water allocation constraint in period  $t$  should be less than the quantity of purchased water and the amount of stored water in the reservoir at the period  $t$  (inequality (1e)).

Water allocated to departments should not outnumber the corresponding demands. Furthermore, it may be desirable to set a lower water quantity limit to some users (inequality (1b)).

In summary, when the state variable is  $S_t$  at the beginning of the  $t$  phase, water allocation decisions should satisfy Formula (1b,e,f).

$$\text{Let } f_t(M_{ti}, Y_{tj}, \dots, M_{Ti}, Y_{Tj}) = \sum_{t=1}^T \sum_{j=1}^J NB_{tj} Y_{tj} - \sum_{t=1}^T \sum_{j=1}^J p_{tj} (D_{tj} - Y_{tj}) - \sum_{t=1}^T \sum_{i=1}^I M_{ti} x_i \quad (1 \leq t \leq T).$$

In order to help decision-makers judge how much water to buy, the formula provides a number of decision variables  $(M_{1j}, Y_{1j}, \dots, M_{Tj}, Y_{Tj})$  which are based on a state variable  $S_t$ . In this way, decision-makers will obtain the benefits from the  $t$  phase to the end of the  $T$  phase.

Under the premise conditions (1b)–(1f), the target of water supply distribution is finding the optimal decision variables of each stage, so that desired net system benefits can be obtained.

From the analysis of the state variables and the decision variables, it is indicated that the state of the adjacent phase is relevant. Therefore, the target of the decision-maker can be obtained according to the recurrence relation between the state variables.

Let  $\text{Max } F_t = \max_{M_{ti}, Y_{tj}, \dots, M_{Ti}, Y_{Tj}} f_t(M_{ti}, Y_{tj}, \dots, M_{Ti}, Y_{Tj})$  ( $1 \leq t \leq T$ ) be the formula indicating that decision-makers buy water according to the decision variables  $(M_{ti}, Y_{tj}, \dots, M_{Ti}, Y_{Tj})$ . In this way, decision-makers will obtain the maximum benefits from the  $t$  phase to the end of the  $T$  phase.

In the real-world water-allocation problem, there exists a variety of uncertainties, such as the water consumption of different seasons, water evaporation during the water-allocation process and the amount of available water resources [22]. In order to simplify subsequent calculations, the uncertainties of the stream flows may be expressed as random variables and a nonlinear constraint of model constraints. Then, those problems can be solved by chance-constrained programming.

### 2.3. Chance-Constrained Programming

Chance-constrained programming is effective for solving problems where random variables exist in the constraints, and making decisions before observing the realization of random variables.

Since the confidence level can be used for describing the probability that the objective function and the constraint satisfy some given requirements, chance constraint programming can provide an explicit means of describing the degree of risk caused by a decision [20,23]. Chance-constrained programming is as follows:

$$\text{Max } f = C(t)X \quad (3a)$$

subject to

$$\Pr[\{t|A_i(t)X \leq B_i(t)\}] \geq 1 - \alpha_i \quad (3b)$$

$$A_i(t) \in A(t), \quad i = 1, 2, \dots, M \quad (3c)$$

where  $X$  is a  $n$ -dimension decision vector;  $A(t)$ ,  $B(t)$ , and  $C(t)$  denote random elements defined on a probability space  $T$ ,  $t \in T$ ;  $A_i$ ,  $B_i$  are the elements of  $A(t)$ ,  $B(t)$ , respectively;

Model (3) is nonlinear, and the set of feasible constraints is convex only for some particular situations, such as the cases when (1)  $A_i$  are certain and  $B_i$  are random (for all  $\alpha_i$  values); (2)  $A_i$  and  $B_i$  are discrete random coefficients with  $\alpha_i \geq \max_{r=1,2,\dots,R}(1 - p_r)$ , where  $p_r$  is the probability associated with realization  $r$ ; and (3)  $A_i$  and  $B_i$  obey Gaussian distributions. When  $A_i$  is deterministic,  $B_i$  is Gaussian distribution ( $B_i \sim N(\mu_i, \sigma_i^2)$ ), the non-linear constraint (1b) of Model (3) can be transformed into respective deterministic equivalent forms:

$$A_i(t)X \leq B_i(t)^{(\alpha_i)}, \quad \forall i \quad (4)$$

where  $B_i(t)^{(\alpha_i)} = F_i^{-1}(\alpha_i)$  and  $F_i^{-1}(\alpha_i)$  are the inverse function of a cumulative distribution function  $F_i(B_i)$ . Here, it can be assumed that  $B_i$  obeys standard normal distribution with standard deviation  $\sigma_i$  and expected value  $\mu_i$ , constraints (4) can be transformed into:

$$\Pr[\{\frac{B_i(t)X - \mu_i}{\sigma_i} \leq \frac{B_i(t)^{\alpha_i} - \mu_i}{\sigma_i}\}] \geq \alpha_i \quad (5)$$

Since  $A_i(t)X \leq B_i(t)$  and  $[B_i(t)X - \mu_i]/\sigma_i$  are a standard normal distribution with mean 0 and variance 1, Formula (5) can be formulated as follows:

$$\Phi\left(\frac{B_i(t)^{\alpha_i} - \mu_i}{\sigma_i}\right) \geq \alpha_i \quad (6)$$

where  $\Phi(\cdot)$  is the cumulative distribution function of a standard normal random variable, thus:

$$B_i(t)^{(\alpha_i)} = \mu_i + \sigma_i \Phi^{-1}(\alpha_i) \quad (7)$$

Model (3) can then be rewritten as follows:

$$\text{Max } f = C(t)X \quad (8a)$$

$$A_i(t)^{(\alpha_i)} \leq \mu_i + \sigma_i \Phi^{-1}(\alpha_i), \quad \forall i \quad (8b)$$

$$A_i(t) \in A(t), \quad \forall i \quad (8c)$$

In general, chance-constrained programming (CCP) can handle uncertainties presented as Gaussian distribution. To deal with uncertainties in the constraint, chance-constrained programming can be added to the dynamic programming decision-making framework, leading to a multi-water resources and multiple users chance-constrained dynamic programming (MMCDP) model. By solving



the MMCDP model, the optimal water supply allocation plan and desired net system benefit can be obtained.

#### 2.4. Multi-Water Sources and Multiple Users Chance-Constrained Dynamic Programming (MMCDP) Model

In the real-world water-allocation system, there are various uncertainties expressed as random variables. For example, water flow may be given as random variables during each planning period, which can be addressed by CCP. The uncertainty of the water allocation system also exists in joint water supply for multi-water resources. The MMCDP model builds a multi-water integrated water supply program and can provide a balance in the deployment of multiple water sources. The MMCDP model can extend the application of inexact optimization methods in multi-water, multi-user water allocation. Adjusting the acceptable risk levels related to the objective function and constraints, a MMCDP model can be formulated as follows:

$$\text{Max } F_t = \sum_{t=1}^T \sum_{j=1}^J NB_{tj} Y_{tj} - \sum_{t=1}^T \sum_{j=1}^J p_{tj} (D_{tj} - Y_{tj}) - \sum_{t=1}^T \sum_{i=1}^I M_{ti} x_i \quad (9a)$$

subject to

$$Y_{tj}^{\min} \leq Y_{tj} \leq D_{tj} \quad \forall t, j \quad (9b)$$

$$V_{\min} \leq LW_t \leq V_{\max} \quad \forall t \quad (9c)$$

$$\sum_{i=1}^I M_{ti} + LW_t - \sum_{j=1}^J Y_{tj} = LW_{t+1} \quad \forall t \quad (9d)$$

$$\sum_{j=1}^J Y_{tj} \leq \sum_{i=1}^I M_{ti} + LW_t \quad \forall t \quad (9e)$$

$$0 \leq M_{ti} \leq S_{ti}^{(\alpha)} \quad \forall t, i \quad (9f)$$

In the formula

$$LW_1 = V_{\min} \quad (9g)$$

$S_{ti}^{(\alpha)}$  presents the amount of available water flow at an acceptable risk level;

$$S_{ti}^{(\alpha)} = \mu_t + \sigma_t \Phi^{-1}(\alpha) \quad (10)$$

when the available water flow is Gaussian distribution ( $M_{ti} \sim N(\mu_t, \sigma_t^2)$ ).

The CCP model can transform uncertainties expressed as different levels of constraint violation probabilities into the cumulative distribution function. Water flow corresponding to different violating constraints through the cumulative distribution function can be obtained (equality (10)).

The detailed algorithm of the MMCDP model can be summarized as follows:

1. Formulate the MMCDP model.
2. Obtain the necessary data of the model, such as the parameters of economy and available water flow, which are expressed as random boundaries corresponding to Gaussian distributions.
3. Set different constraint-violation risks and objective aspiration level by decision-makers.
4. Translate constraint violation probabilities into the cumulative distribution function.
5. By solving the MMCDP Model (9), the optimal water supply allocation plan and desired net system benefit can be obtained.

### 3. Case Study

#### 3.1. Area Description

Beijing is located in the northwest edge of the North China Plain and is in the typical warm temperate zone with a semi-humid continental monsoon climate. The city's average annual rainfall is 585 mm. Due to socio-economic development, the population in Beijing has become denser, which exacerbates the imbalance between water supply and demand [24]. According to the Beijing Statistical Yearbook 2008–2015, the average annual consumption of water resources reached 36 hundred million cubic meters. However, the total annual water resources was only 27 hundred million cubic meters and the water shortage gap reached 900 million cubic meters [25,26]. Since 2008, at least 25 hundred million cubic meters of groundwater has been exploited in Beijing, accounting for about 70% of the annual water supply. At the same time, the over-exploitation of groundwater reach nearly eight hundred million cubic meters [27]. From 1999 to 2012, Miyun and Guanting Reservoir's water inflow was 380 million cubic meters, which was less than a quarter of the average annual demand. Since 2014, Beijing has begun to receive water from the South-to-North Water Transfer Project, which will reach about 10 hundred million cubic meters annually. These water resources will ease the tension of Beijing's water supply to some extent. Therefore, the external water transfer, local surface water and groundwater form the multi-water supply pattern of joint water supply in Beijing.

As the outside water belongs to seasonal water supply, in the dry season, the water supply may fail to meet the Primary, Secondary, and Tertiary industrial demands. The water sources problem concerns how to optimally distribute the limited water among the Primary, Secondary, and Tertiary industry and storage-reservoir whilst striving to obtain the maximum economic benefits. In a real-world water management system, there are various uncertainties related to economic factors and hydrological data. The decision-makers are responsible for predetermining the amount of water for different departments. During all the planning periods, all water-use sectors need to make proper decisions on their investment and production plan according to the amount of water they could obtain. Moreover, economic factors such as the revenue and penalty could vary in different periods. The uncertainties could be transformed into random boundaries corresponding to Gaussian distributions, which cannot be solved by traditional optimization methods. Therefore, in order to support sustainable water management, it is desired to develop new optimization methods [28].

#### 3.2. Data Preparation

Among all water resources, surface water (reservoir) is subject to the restrictions of the reservoir storage capacity and water transfer conditions; groundwater is subject to the restrictions of mining equipment and capacity; water transfer is subject to the restrictions of transportation conditions. Due to significant seasonal changes, the obtainable water shows obvious probability characteristics. According to the Beijing Statistical Yearbook 2016, the decision-maker would forecast the quantity of water supply from each water resource. Table 3 shows the available water resources with random boundaries corresponding to Gaussian distributions in four planning periods. Tables 4 and 5 display the related economic data according to the reports from Beijing statistics department. As shown in Tables 4 and 5, different users' benefits are changing over time. At the same time, the penalties caused by the water shortage would vary in accordance with these changes. Table 6 shows the available water flow levels under different probabilities ( $\alpha$ ) of violating constraints. The violation constraint  $\alpha = 0.05, 0.10$  and  $0.15$  shows that the available water resources situations are drought, normal and flood, respectively. The available water in dry years is two hundred million cubic meters of water (two hundred million cubic meters of water accounts for about 7% of the total water consumption) less than the normal available water resources situation. The available water in high flow years is one hundred million cubic meters of water more than the normal available water resources situation. According to the Beijing Statistical Yearbook 2016, the water demand of Beijing City next year could be



predicted. The forecasting result of the Primary industry, Secondary industry, and Tertiary industry is shown in Table 7.

**Table 3.** The obtainable water resources in four planning periods.

Types	Water Amount in Different Periods (Unit: $10^7 \text{ m}^3$ )			
	Spring	Summer	Autumn	Winter
Surface water	$N(25, 5^2)$	$N(30, 3^2)$	$N(20, 4.5^2)$	$N(25, 5^2)$
Groundwater	$N(38, 4^2)$	$N(52, 5^2)$	$N(34, 4^2)$	$N(43, 5^2)$
Water transfer	$N(17, 2.5^2)$	$N(26, 4.5^2)$	$N(12, 4^2)$	$N(19, 4^2)$

**Table 4.** The benefits of each water-use department in four planning periods.

Water-Use Sectors	Water Benefit in Different Periods and Different Sectors (Unit: $\text{RMB}/\text{m}^3$ )			
	Spring	Summer	Autumn	Winter
Primary industry	15	18	32	10
Secondary industry	891.1	891.1	891.1	891.1
Tertiary industry	980	1200	925	700

**Table 5.** The penalty of each water-use department in four planning periods.

Water-Use Sectors	Water Penalty in Different Periods and Different Sectors (Unit: $\text{RMB}/\text{m}^3$ )			
	Spring	Summer	Autumn	Winter
Primary industry	30	40	60	30
Secondary industry	1100	1100	1100	1100
Tertiary industry	1000	1500	1000	1000

**Table 6.** The available water flows under different  $\alpha$  levels.

	Water Amount in Different Periods (Unit: $10^7 \text{ m}^3$ )			
	Spring	Summer	Autumn	Winter
$\alpha = 0.15$				
Surface water	19.8	26.9	15.3	19.8
Groundwater	33.8	46.8	29.8	37.8
Water transfer	14.4	21.3	6.8	14.8
$\alpha = 0.1$				
Surface water	18.6	26.2	14.2	18.6
Groundwater	32.9	45.6	28.9	36.6
Water transfer	13.8	20.2	5.6	13.9
$\alpha = 0.05$				
Surface water	16.8	25.1	12.6	16.8
Groundwater	31.4	43.8	27.4	34.8
Water transfer	12.9	18.6	3.8	12.4

**Table 7.** The forecasting of water demand in Beijing city by sector units.

Types	Water Demand in Different Periods (Unit: $10^7 \text{ m}^3$ )			
	Spring	Summer	Autumn	Winter
Primary industry	15	28	24	20
Secondary industry	12	20	15	17
Tertiary industry	33	65	35	45

When the water amount of South-to-North Water surpasses Beijing's water demand and Guanting Reservoir's storage capacity, Miyun Reservoir can play a role in reverse regulation. The redundant

water can be pumped into the Miyun Reservoir through the Beijing Miyun Drainage Channel. Miyun Reservoir and Guanting Reservoir storage capacity is 186 and 37.5 million m<sup>3</sup>, respectively [25]. Hence, the largest water storage capacity of Beijing City is 223.5 million m<sup>3</sup>.

In the water management system, the following points should be considered. Taking into account the particularity of the agricultural sector, the rate of water supply of the agricultural sector should be at least 50% in the process of distributing water. The total price of surface water, groundwater and water transfer is 0.16 RMB/m<sup>3</sup>, 9.92 RMB/m<sup>3</sup> and 9.83 RMB/m<sup>3</sup>, respectively. The minimum valuable water storage of Miyun Reservoir and Guanting Reservoir is zero.

#### 4. Data Analysis of Results

The objective function is to maximize the total economic benefits. In this study, the decision-makers need to allocate water to multiple users. In order to maximize the system benefits, the decision-makers should also consider the benefit/penalty and random variables in available water resources. Through incorporating different probabilities of violating constraints into the MMCDP model, the results can provide a number of alternative decisions under different risk levels. In addition, the proposed MMCDP is able to reflect trade-offs between system benefits and associated risks caused by uncertainties in the objective function and constraints. Therefore, decision-makers can put forward a specific management plan based on their preferences to the resulting degrees of uncertainty.

Deficits would occur due to the insufficient obtainable water which is used to satisfy the water demand of each water-use industry. Under such a situation, the actual water allocation is the difference between the water demand and the associated water shortage (i.e., water supply = water demand – water shortage) under given available water resources with a related probability level. In the case of insufficient water supply, the water allocation should be firstly assigned to the Tertiary industry, secondly to the Secondary industry, and lastly to the Primary industry.

As shown in Figures 2–4, water consumption shows a significant seasonal trend, and the Tertiary industry is the biggest user of water. At the same time, the water consumption of the secondary industry is the least of all water-use sectors. From the results of water distribution, the industrial water accounts for merely 30~50% of the Tertiary industrial water. Simultaneously, the amount of water allocated to agriculture reaches the low limit of agricultural water supply in all probabilities of violating constraints during all planning periods. However, the amount of water allocated to the Secondary industry could meet the industrial demand in all planning periods. There are a number of seasons, wherein the water demand of the Tertiary industry cannot be satisfied.

Figure 2 indicates that the water consumption of the tertiary industry should be favored in the second quarter. This is because the highest profits would be generated by the Tertiary industry when its water demand can be satisfied; meanwhile, it would suffer the highest penalty if the water demand could not be delivered. In comparison, the Secondary industry and the Primary industry would correspond to relatively lower profits and lower penalties. To allocate water to the Tertiary industry, the benefits (e.g., tourism) may be much more significant during summer [29]. As shown in Figures 3 and 4, priority should be given to the water consumption of the Secondary industry in the third quarter. Because the Tertiary industry's penalty caused by a lack of water is reduced significantly, the water supply should give priority to the Secondary industry and lastly to the Primary industry.

Based on the analysis of Figures 2–4 and Table 5, the reason for the occasional water shortage in the Tertiary industry is that the amount of water demand and the penalty of the Tertiary industry is in off-season. Thus, the Secondary industry would take priority for water supply. According to the resulting solutions from the proposed method, decision-makers can make a compromised decision between allocating water to supply and storing water in the reservoir to guarantee water for the next quarter.

Under drought conditions, available water resources would reduce. As shown in Figure 4, the amount of water supply in the Tertiary industry would decrease. The Primary industry and the Secondary industry would not change in water supply. As shown in Table 8, a lower violating

constraint would lead to relatively lower benefits. In the case of  $\alpha = 0.05$ , the optimal net benefit is 2064.8 billion RMB. Although a lower violating constraint would result in a lower risk of water shortage, there would be a potential waste of water resources when the level of obtainable water flow is high.

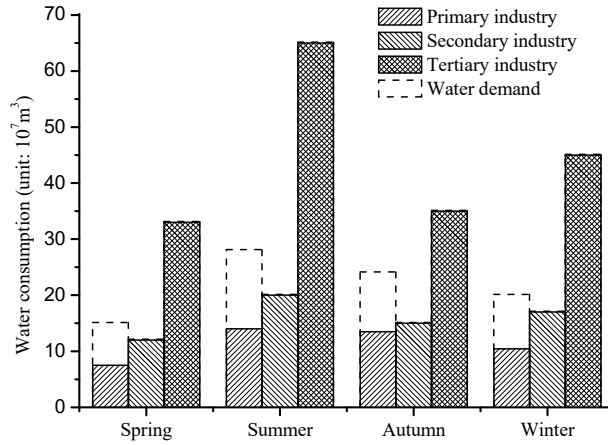


Figure 2. Water consumption of various sectors under violating constraint  $\alpha = 0.15$ .

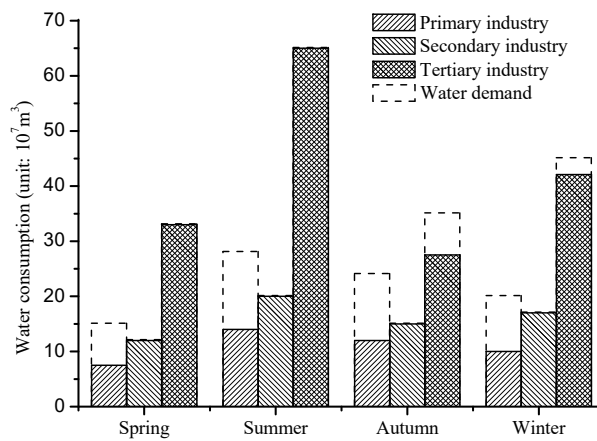


Figure 3. Water consumption of various sectors under violating constraint  $\alpha = 0.10$ .

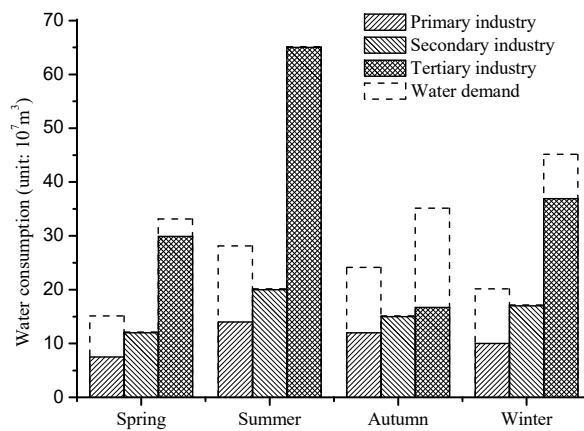
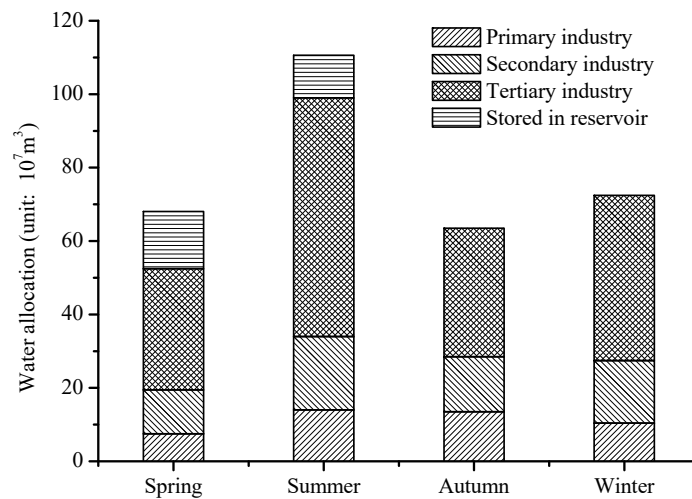


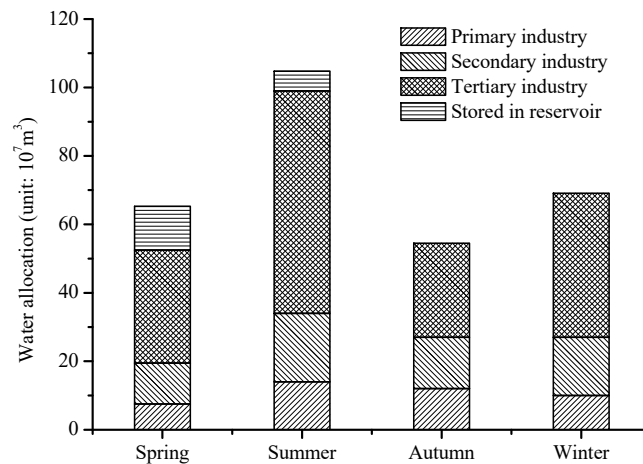
Figure 4. Water consumption of various sectors under violating constraint  $\alpha = 0.05$ .

Generally, a higher violating constraint would lead to relatively higher benefits associated with a higher risk of penalty caused by water shortage. In comparison, when the value of violating constraint  $\alpha$  becomes higher, the amount of water allocated to each user would increase over all phases (as shown in Figures 2–4). Meanwhile, the system benefit would increase with the reduction of system risk. Therefore, it is necessary for policymakers to make a trade-off between the system benefits and the associated risks.

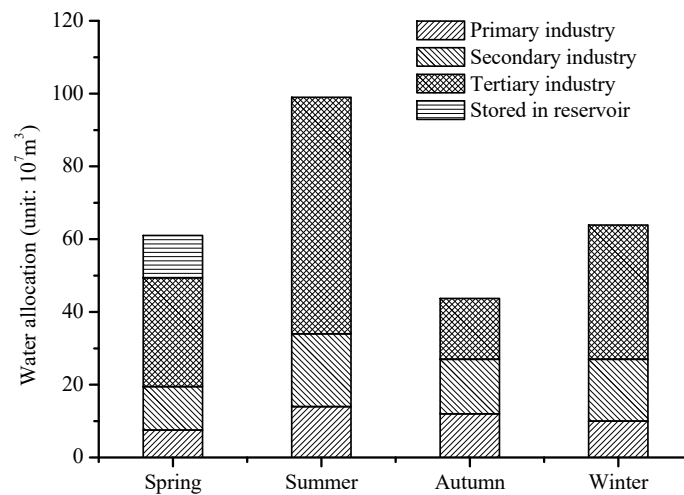
Figures 5–7 show the allocation of water sources among multiple users with different violating constraints  $\alpha$ . In all probabilities for violating constraints, part of the water in the first quarter would be stored in the regulating reservoir to ensure the water supply of the next quarter. In comparison, the amount of water allocated to the Tertiary industry and the Secondary industry is much more than the Primary industry in each period. If the decision-maker does not store water in the reservoir, the water for the current quarter would be guaranteed. However, the overall benefits may be reduced. Meanwhile, in order to satisfy the requirements of water consumption in the next quarter, the decision-maker should store water in reservoirs. At this time, due to water shortage, the corresponding water-using departments will incur penalties.



**Figure 5.** The allocation results of water sources and the quantity stored in reservoirs under violating constraint  $\alpha = 0.15$ .

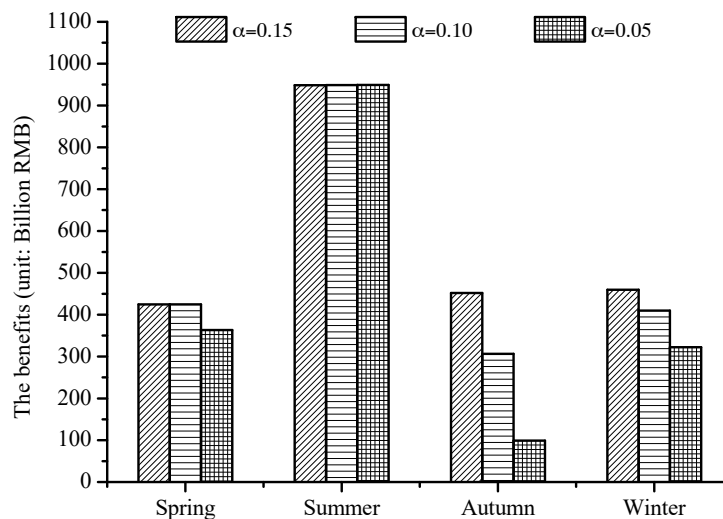


**Figure 6.** The allocation results of water sources and the quantity stored in reservoirs under violating constraint  $\alpha = 0.10$ .



**Figure 7.** The allocation results of water sources and the quantity stored in reservoirs under violating constraint  $\alpha = 0.05$ .

Figure 8 shows that regardless of the probabilities of violating constraints  $\alpha$ , the benefit in summer is always the most; the decision-makers should give priority to water supply in summer.



**Figure 8.** The economic benefit of three industries in different seasons under different violating constraints.

Figure 9 and Table 8 show the benefits of different departments in all planning periods. The Secondary industry has the most stable benefit in all probabilities for violating constraints. The benefit of the Secondary industry would reach 570.3 billion RMB, accounting for a third of the Tertiary industry’s benefit. The agricultural benefit is the lowest in the three sectors, only being 9 billion RMB. Therefore, from the perspective of acquiring more benefit, the water supply should be firstly assigned to the Tertiary industry and lastly to the Primary industry. In the case of  $\alpha = 0.15$ , the optimal net benefit would be 2321.5 billion RMB. When  $\alpha = 0.10$ , the optimal net benefit is 2231.1 billion RMB. When  $\alpha = 0.05$ , the optimal net benefit is 2064.8 billion RMB. The proportion of water allocation of Primary, Secondary and Tertiary industry would be 40%, 38% and 22%, respectively. The results of the MMCDP model indicate that the Tertiary industry would consume the most water, followed by the Secondary industry and finally the Primary industry. In terms of economic benefits, the average benefit of the system in three different violating constraints would be 2205 billion RMB and 31.9% higher than the real benefit.

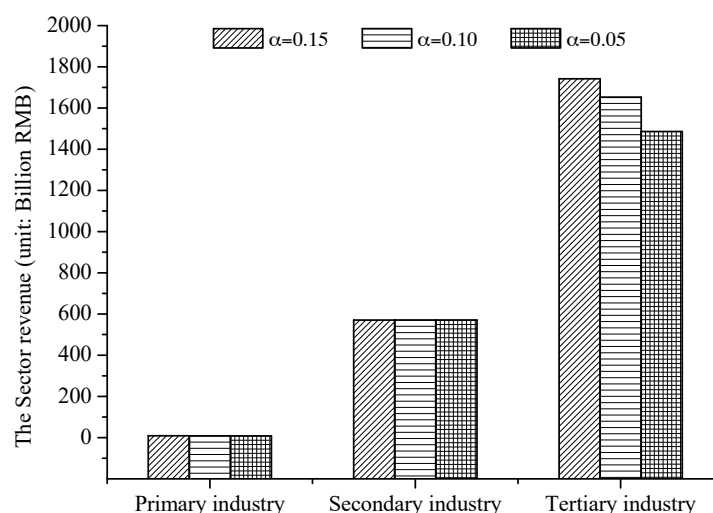


Figure 9. The different sector revenues under different violating constraints.

Table 8. The benefit of each water-use department in the whole horizon.

Water-Use Sectors	Water Benefit under Different Violating Constraints (Unit: Billion RMB)		
	$\alpha = 0.15$	$\alpha = 0.1$	$\alpha = 0.05$
Primary industry	9	8.5	8.5
Secondary industry	570.3	570.3	570.3
Tertiary industry	1742.2	1652.3	1486
Total	2321.5	2231.1	2064.8

As shown in Figures 2–4 and 9, the agricultural benefit would account for merely 1/60 of the Secondary industry's and 1/180 of the Tertiary industry's benefit. The minimum amount of water is allocated to the agricultural sector because the agricultural sector obtains the least benefit. As it has the least amount of water demand, the Secondary industry would obtain the most stable water supply of all departments. Simultaneously, not being affected by the seasons, its penalty would be constant in all planning periods.

In summary, decision-makers should give top priority to the water supply of the Tertiary industry in summer. In the other quarter, because the penalties of the Tertiary industry caused by water shortage will be less than the penalties of the Secondary industry, there would be no water shortage for the Secondary industry over the planning horizon except in summer. At the same time, decision-makers should appropriately reduce the water consumption in the other quarters to meet the water demand in summer. In terms of economic benefits, decision-makers can gain more revenue from the reasonable water allocation scheme provided by MMCDP. In addition, the optimized water-allocation schemes for different decision-makers would vary with the change of system objective (e.g., environmental benefits).

## 5. Conclusions

In this study, a multi-water resources and multiple users chance-constrained dynamic programming (MMCDP) model of water allocation has been developed by integrating chance-constrained programming into the dynamic programming decision-making framework. This model can not only solve the problem of probability distribution of water supply, but also provide a new idea for optimizing the allocation of a city's water resources coupled with reservoir regulation.

The existing risk-based interactive multi-stage stochastic programming (RIMSP) approach can only deal with a single water source in the water resource allocation model. However, in the real world, model parameters are associated with multiple complexities. Urban water supply is no longer



from a single source. Multiple water sources can provide a strong water guarantee and alleviate the contradiction between water supply and demand which will make the water supply system more complicated and put forward new requirements for local water resources allocation management. In addition, the water allocation schemes under extreme situations (drought and floods) were analyzed. The different schemes can support managers to obtain desired net system benefit and an effective water resources management plan. Comparing with the RIMSP model, the developed model can not only help decision-makers to evaluate the trade-offs between the economic objectives and the associated risks, but also make a balance amongst the deployment of multiple water sources.

The proposed MMCDP has been applied to a case study of Beijing's water resources management to demonstrate its applicability. The water sources would include transferred water, groundwater and surface water. At the same time, Miyun Reservoir and Guanting Reservoir would act as extra water sources to re-participate water distribution in the new phase. The model can be used to optimize the water supply allocation of multiple water sources under different available water resources situations and generate the optimal allocation of water resources under different probabilities of violation  $\alpha$ . The obtained schemes can minimize the comprehensive cost of the system, maximize the expected benefit, and avoid the occurrence of system risk. Although this study is the first attempt at designing a water resources allocation system through MMCDP, the results suggest that the proposed method can be applied to other countries where freshwater resources are scarce, especially in those with reservoir systems. Moreover, it may be suitable for other inexact stochastic parameter researches, such as economic parameters, water flow and so on.

**Acknowledgments:** This research was supported by the National Natural Science Foundation of China (61471171) and the Fundamental Research Funds for the Central Universities (2015ZZD08).

**Author Contributions:** Wei Li and Kuo Jiao conceived and designed the model; Kuo Jiao operated the model; Kuo Jiao and Zhe Bao analyzed the data; Wei Li and Guohe Huang contributed materials/analysis tools; Kuo Jiao wrote the paper; Yulei Xie, Lingbo Fu and Jiliang Zhen made suggestions for improvement of the paper.

**Conflicts of Interest:** The authors declare no conflict of interest.

## References

1. Xu, Y.; Huang, G.H.; Qin, X.S. Inexact two-stage stochastic robust optimization model for water resources management under uncertainty. *Environ. Eng. Sci.* **2009**, *26*, 1765–1776. [[CrossRef](#)]
2. Yang, Q.; Boehm, C.; Scholz, M.; Plant, C.; Shao, J. Predicting multiple functions of sustainable flood retention basins under uncertainty via multi-instance multi-label learning. *Water* **2015**, *7*, 1359–1377. [[CrossRef](#)]
3. Wang, Y.Y.; Huang, G.H.; Wang, S.; Li, W.; Guan, P.B. A risk-based interactive multi-stage stochastic programming approach for water resources planning under dual uncertainties. *Adv. Water Resour.* **2016**, *94*, 217–230. [[CrossRef](#)]
4. Yamout, G.; El-Fadel, M. An optimization approach for multi-sectoral water supply management in the greater beirut area. *Water Resour. Manag.* **2005**, *19*, 791–812. [[CrossRef](#)]
5. Han, Y.C.; Huang, G.H.; Li, C.H. An Interval-Parameter Multi-Stage Stochastic Chance-Constrained Mixed Integer Programming Model for Inter-Basin Water Resources Management Systems under Uncertainty. In Proceedings of the International Conference on Fuzzy Systems and Knowledge Discovery, Hong Kong, China, 1–6 June 2008; pp. 146–153.
6. Chen, F.; Huang, G.H.; Fan, Y.R. Inexact multistage fuzzy-stochastic programming model for water resources management. *J. Water Resour. Plan. Manag.* **2015**, *141*, 04015027. [[CrossRef](#)]
7. Xie, Y.L.; Xia, D.H.; Huang, G.H.; Li, W.; Xu, Y. A multistage stochastic robust optimization model with fuzzy probability distribution for water supply management under uncertainty. *Stoch. Environ. Res. Risk Assess.* **2015**, 1–19. [[CrossRef](#)]
8. Karamouz, M.; Goharian, E.; Nazif, S. Development of a reliability based dynamic model of urban water supply system: A case study. In Proceedings of the World Environmental and Water Resources Congress, Albuquerque, NM, USA, 20–24 May 2012; pp. 2067–2078.
9. Huang, G.H. A hybrid inexact-stochastic water management model. *Eur. J. Oper. Res.* **1998**, *107*, 137–158. [[CrossRef](#)]

10. Li, Y.P.; Huang, G.H.; Nie, S.L.; Mo, D.W. Interval-parameter robust quadratic programming for water quality management under uncertainty. *Eng. Optim.* **2008**, *40*, 613–635. [[CrossRef](#)]
11. Guo, P.; Huang, G.H. Two-stage fuzzy chance-constrained programming: Application to water resources management under dual uncertainties. *Stoch. Environ. Res. Risk Assess.* **2009**, *23*, 349–359. [[CrossRef](#)]
12. Li, Y.P.; Huang, G.H.; Wang, G.Q.; Huang, Y.F. Fswm: A hybrid fuzzy-stochastic water-management model for agricultural sustainability under uncertainty. *Agric. Water Manag.* **2009**, *96*, 1807–1818. [[CrossRef](#)]
13. Li, Y.P.; Huang, G.H.; Huang, Y.F.; Zhou, H.D. A multistage fuzzy-stochastic programming model for supporting sustainable water-resources allocation and management. *Environ. Model. Softw.* **2009**, *24*, 786–797. [[CrossRef](#)]
14. Xie, Y.L.; Li, Y.P.; Huang, G.H.; Li, Y.F.; Chen, L.R. An inexact chance-constrained programming model for water quality management in binhai new area of tianjin, china. *Sci. Total Environ.* **2011**, *409*, 1757–1773. [[CrossRef](#)] [[PubMed](#)]
15. Xu, Y.; Huang, G.H.; Shao, L.G. Agricultural farming planning and water resources management under fuzzy uncertainty. *Eng. Optim.* **2014**, *46*, 270–288. [[CrossRef](#)]
16. Wang, B.; Li, W.; Huang, G.H.; Liu, L.; Ji, L.; Li, Y. Urban water resources allocation under the uncertainties of water supply and demand: A case study of urumqi, china. *Environ. Earth Sci.* **2015**, *74*, 3543–3557. [[CrossRef](#)]
17. Scott, C.A.; Bailey, C.J.; Marra, R.P.; Woods, G.J.; Ormerod, K.J.; Lansey, K. Scenario planning to address critical uncertainties for robust and resilient water–wastewater infrastructures under conditions of water scarcity and rapid development. *Water* **2012**, *4*, 848–868. [[CrossRef](#)]
18. Charnes, A.; Cooper, W.W.; Kirby, M.J.L. Chance-constrained programming: An extension of statistical method 1. *Optim. Methods Stat.* **1971**, 391–402. [[CrossRef](#)]
19. Huang, G.H.; Loucks, D.P. An inexact two-stage stochastic programming model for water resources management under uncertainty. *Civ. Eng. Environ. Syst.* **2000**, *17*, 95–118. [[CrossRef](#)]
20. Yang, N.; Wen, F.S. Risk-constrained multistage transmission system expansion planning. *Autom. Electr. Power Syst.* **2005**, *29*, 28–33.
21. Rahmani, F.; Behzadian, K. Sequential multi-objective evolutionary algorithm for a real-world water distribution system design ☆. *Procedia Eng.* **2014**, *89*, 95–102. [[CrossRef](#)]
22. Beh, E.H.Y.; Maier, H.R.; Dandy, G.C. Development of a modelling framework for optimal sequencing of water supply options at the regional scale incorporating sustainability and uncertainty. In Proceedings of the 19th International Congress on Modelling and Simulation, Perth, Australia, 12–16 December 2011.
23. Liu, X.M.; Huang, G.H.; Wang, S.; Fan, Y.R. Water resources management under uncertainty: Factorial multi-stage stochastic program with chance constraints. *Stoch. Environ. Res. Risk Assess.* **2016**, *30*, 945–957. [[CrossRef](#)]
24. Li, Y.P.; Huang, G.H.; Nie, S.L. An interval-parameter multi-stage stochastic programming model for water resources management under uncertainty. *Adv. Water Resour.* **2006**, *29*, 776–789. [[CrossRef](#)]
25. Zhang, Y.N.; Tian, F.Q.; Hu, H.C.; Qi, Z.C. Joint operation model of multiple water sources in Beijing. *Shui Li Xue Bao* **2014**, *45*, 844–849.
26. Yu, B.; Liang, G.; He, B.; Dong, L.; Zhou, H. Modeling of joint operation for urban water-supply system with multi-water sources and its application. *Nonlinear Differ. Equ. Appl. Nodda* **2015**, *14*, 499–525.
27. Han, Y.; Xu, S.G.; Xu, X.Z. Modeling multisource multiuser water resources allocation. *Water Resour. Manag.* **2008**, *22*, 911–923. [[CrossRef](#)]
28. Larson, K.; White, D.; Gober, P.; Wutich, A. Decision-making under uncertainty for water sustainability and urban climate change adaptation. *Sustainability* **2015**, *7*, 14761–14784. [[CrossRef](#)]
29. Kondili, E.; Kaldellis, J.K.; Papapostolou, C. A novel systemic approach to water resources optimisation in areas with limited water resources. *Desalination* **2010**, *250*, 297–301. [[CrossRef](#)]



© 2017 by the authors. Licensee MDPI, Basel, Switzerland. This article is an open access article distributed under the terms and conditions of the Creative Commons Attribution (CC BY) license (<http://creativecommons.org/licenses/by/4.0/>).

Reproduced with permission of copyright owner.  
Further reproduction prohibited without permission.